

REACTIVE POWER MANAGEMENT

RM Series

1. INTRODUCTION

1.1 About User Manual

This User Manual is designed to help you for quick installation of RM Series. Before installation and operation please, read this section very carefully.

1.2 Precautions for Safe Use and Installation

- Maintenance, installation and operation of RM Series must be performed only by the qualified electricians.
- Switch off power before working on the equipment.
- Do not operate RM Series under operating voltage.
- Do not open the RM Series housing. There are no user serviceable parts inside.
- RM Series are connected to the network by means of current transformer. Do not disconnect the current transformer terminals, if you disconnect them, be sure to short circuit or connect them to another parallel load having sufficiently low impedance. In case of failure dangerously high voltage at the secondary side of current transformer may cause an electric shock.
- Do not use this product for any other purpose than its original task.
- When the device is connected to the network, do not remove the front panel.
- Do not clean the device with solvent or the like. Only clean with a dried cloth.
- Verify correct terminal connections when wiring.
- Electrical equipment should be serviced only by your competent seller.
- Only for rack panel mounting.
- No responsibility is assured or any of its subsidiaries for any consequences arising out of the use of this material.

2. GENERAL

Power Factor Controllers are used for measurement and control of power factor control units for central reactive power compensation. The Power Factor measured by RM Series are compared with the set point values and in order to provide necessary compensation. Power Factor Controller switches capacitor banks ON and OFF automatically. RM Series are micro controller relay, designed for above application in 144x144 case for flush mounting with rear plug-in connectors. In addition it displays the system's $\text{Cos}\phi$, in Automatic Operating Mode, RM Series display the RMS value of Voltage (V), Current (I), Active Power (w), Reactive Power (Var) and Apparent Power (VA) of measuring phase.

3. FRONT PANEL SPECIFICATIONS

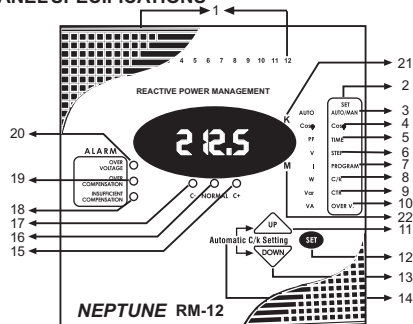

On the front panel of RM Series, there are warning LEDs display and 3 buttons for Setting.

3.1 Buttons and LEDs

- 1,2,.....,12 : Shows the status of each capacitor step.
- SET Menu : Show the Menu option that correspond to the LEDs.
- AUTO/MANLED : If this LED is Continuously ON. RM Series are in Automatic Mode. It is blinking RM Series are in Manual mode. By pressing SET button 3 seconds, you enter to Menu and change operating Mode. (Refer to 5.1)
- $\text{Cos}\phi$ LED : By pressing SET button 3 seconds $\text{Cos}\phi$ adjust can be made by selecting this LED (Refer to 5.3) In Automatic Mode, When $\text{Cos}\phi$ LED is selected by pressing UP and DOWN buttons. System's $\text{Cos}\phi$ and ind/cap state is displayed (Refer to 5.10)
- TIME/Pf LED : By pressing SET button 3 seconds you enter to Menu and Step Time adjustment is made by selecting this LED. (Refer to 5.4). In Automatic Mode, When this LED is selected by pressing UP and DOWN buttons, system's Power Factor is displayed (Refer to : 5.11)
- STEP/V LED : By pressing SET button 3 seconds, you enter to Menu and Step Number adjustment is made by selecting this LED. (Refer to 5.5) In Automatic Mode when this LED is selected by pressing UP and DOWN buttons phase voltage (v) is displayed. (Refer to 5.12)
- Program/LED : By pressing SET button 3 seconds: you enter to Menu and Power Sequence adjustment is made by selecting this LED. (Refer to 5.6) In Automatic Mode, when this LED is selected by pressing UP and DOWN buttons phase current (I) is displayed (Refer to: 5.12)
- C/k - W LED : By pressing SET button 3 seconds: you enter to Menu Manual C/k adjustment is made by selecting this LED. (Refer to 5.7) In Automatic Mode, when this LED is selected by, pressing and DOWN buttons systems's Active Power (W) is displayed. (Refer to 5.13)

- CTR-VAr LED : By pressing SET button 3 seconds: you enter to Menu and Current transformer Ratio Programming is made by selecting this LED. (Refer to 5.8) In Automatic Mode, when this LED is selected by pressing UP and DOWN buttons system's Reactive Power (Var) is displayed. (Refer to 5.14)
- Over V/VA LED : By pressing SET button 3 seconds: you enter to Menu and Protection of Capacitor steps Against Over Voltage function is made by selecting this LED. (Refer to 5.9) Protection of Capacitor steps Against Over Voltage function is made by selecting this LED. (Refer to 5.9) In Automatic mode, when this LED is selected by, pressing UP and DOWN buttons system's Apparent Power (VA) is displayed.. (Refer to 5.15)
- UP Button : To move up in the Menu.
- SET Button : Enter button for different settings.
- DOWN Button : To move down in the Menu
- Automatic C/k Setting : Automatical C/k adjustment is started by pressing UP and DOWN buttons together at the same time. (Refer to 5.2)
- C+LED : This LED is ON when RM Series switches capacitor steps on.
- NORMAL LED : This LED is ON when the targeted compensation is achieved
- C-LED : This LED is ON when RM Series switch capacitor steps off.
- Insufficient Compensation LED : This warning LED is ON when insufficient compensation occurs. (Refer to 6.1.2)
- Over Compensation LED : This warning LED is ON when over compensation occurs (Refer to 6.1.3)
- Over Voltage LED : This warning LED is ON when over voltage occurs. (Refer to 6.1.1)
- K (Kilo) Light : When this LED is ON displayed value must be multiplied by 1000.
- M (Mega) LED : When this LED is ON displayed value must be multiplied by 10^6 .

4. CONNECTION DIAGRAM

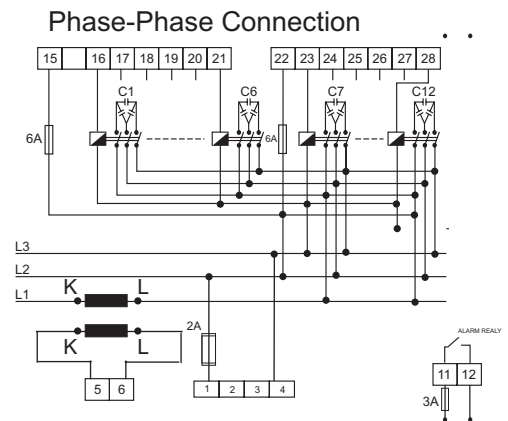
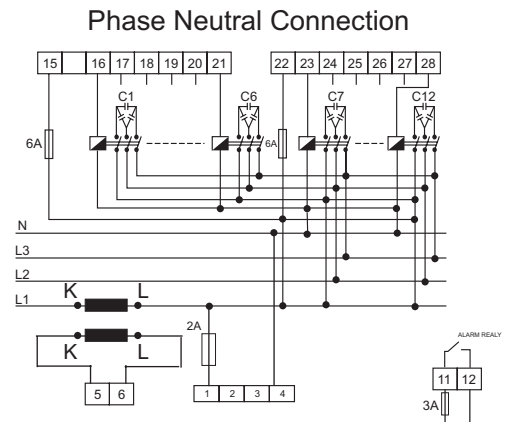

Warnings:

- Connection of circuit breaker is highly recommended between the network and The power supply input of the device.
- Circuit breaker must be in close proximity to the device.
- Circuit breaker must be marked as the disconnecting device for the equipment.
- All the used fuses must be FF type and the current values of the fuses must be 2A, 3A, and 6A.

REACTIVE POWER MANAGEMENT

RM Series

5. CONTROL AND MENU OPERATIONS

All settings are made by the Menu. The set values, except operating mode are kept in memory even if the device is switched off. When it is switched on, it starts compensation with the values stored in the memory in Automatic Operating Mode. After entering Menu by pressing SET button 3 seconds and if you don't make any adjustments during 20 seconds, RM Series operates with the previously stored values.

To quit Menu without storing any operation, press UP-DOWN buttons until the EXC symbol is displayed and then press SET button.

The details of controls and adjustments are explained in the following sections

5.1 Selection of operating mode (Automatic / Manual Mode)

Two Operating Modes are valid for switching on/off the capacitor steps.

- 1) Automatic Operating Mode: The capacitor steps are controlled by RM Series Automatically.
- 2) Manual Operating Mode: the capacitor steps are switched on/off, manually. Mode selection is done as followed: Mode selection is done as followed.

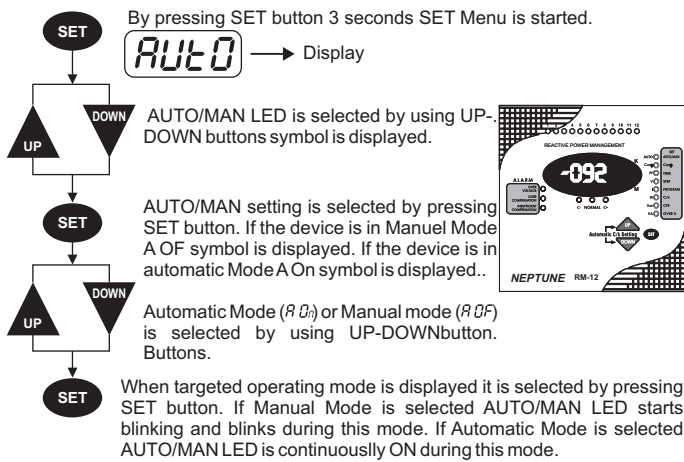

5.1.1 Switching of the Capacitor Steps Manually

When RM Series are in Manual Mode, capacitors are connected by pressing UP button. Each time UP button is pressed C+LED is ON, and one step is connected accordingly. NORMAL LED will be ON after the disconnection of the step. This operation must be repeated to connect more steps. Capacitors steps are disconnected by pressing DOWN button. Each time UP button is pressed C-LED is ON, and one step is disconnected after a delay time; NORMAL LED will be ON after the disconnection of the step. This operation must be repeated To disconnect more steps.

5.2 Automatic C/k Adjustment

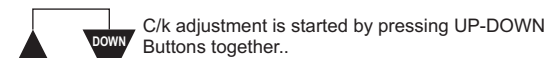

5.3 Cosφ Adjustment

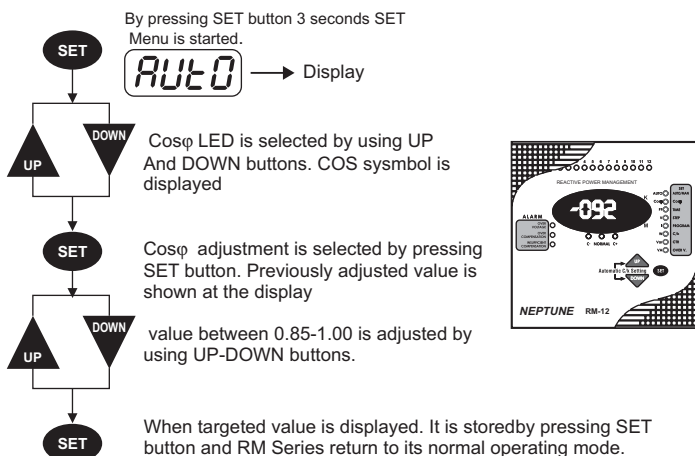

5.4 Step Time Adjustment

By pressing ton 3 seconds SET Menu is started.

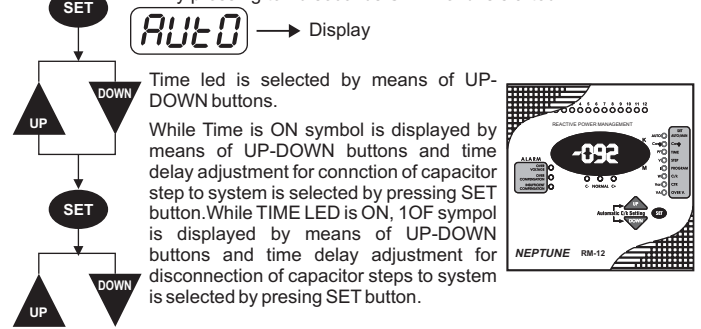

5.5 Step Number Selection

By pressing SET button 3 seconds SET Menu is started.

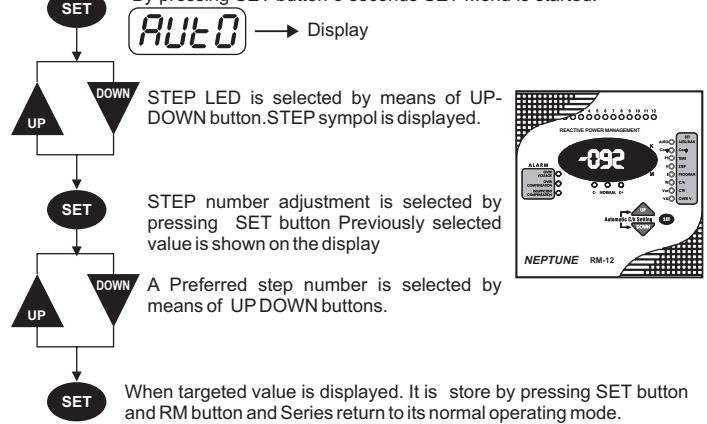

5.6 Switching Program Selection

By pressing SET button 3 seconds SET Menu is started.

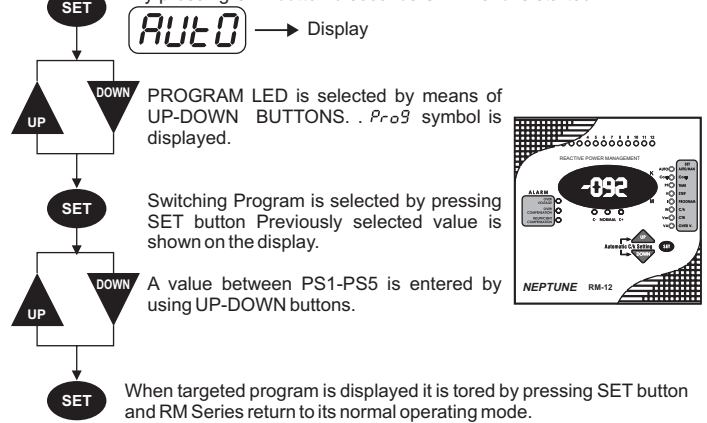

5.7 Selection of C/k Value by the User

By pressing SET BUTTON 3 seconds SET Menu is started

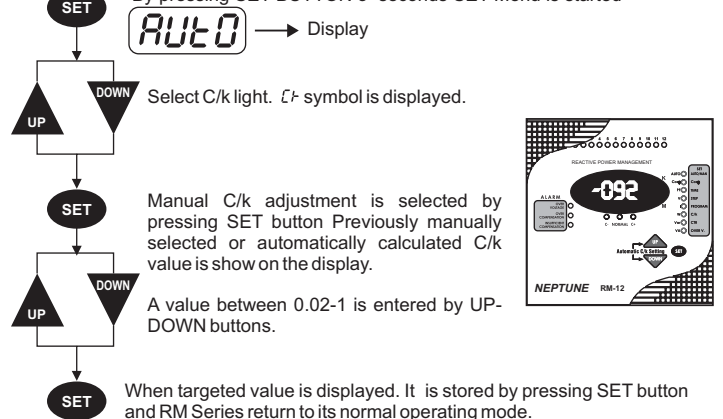

REACTIVE POWER MANAGEMENT

RM Series

5.8 Selection of Current Transformer Primary Value

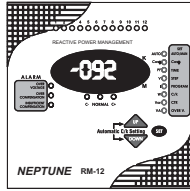
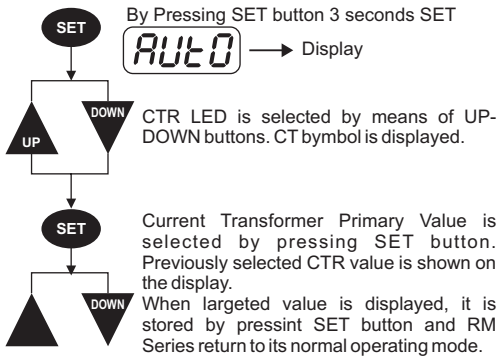

5.9 Protection of Capacitor Steps Against Over Voltage

This is selectable function, either O OF (Over Voltage Protection Off) or an Over Voltage value between 410-480V can be selected. If "Over Voltage" occurs when Over Voltage Value is selected (between 410-480V, then all the capacitor steps switch off, OVER VOLTAGE LED turns on and alarm relay activates. And if RM Series are on Manual Mode, it switches to Automatic Mode.

If 0 OF is selected; Then over voltage protection is disabled. Note: for over voltage values of RM Series with 380-415 VAC, please kindly check technical specifications on page 4.

Setting can be made as followed.

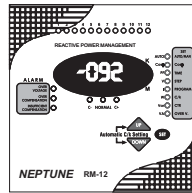
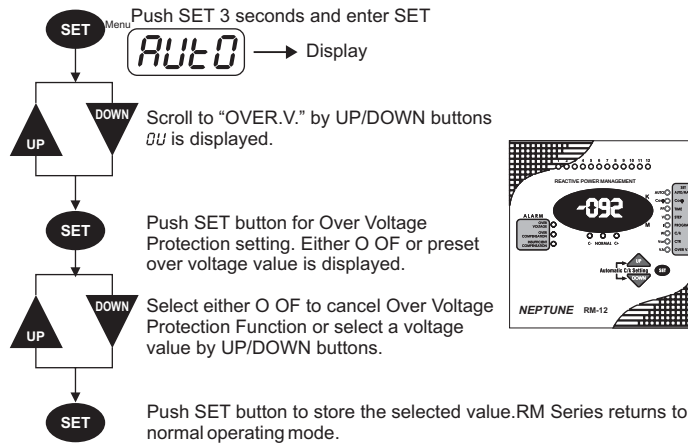

5.10 Display of $\text{Cos}\phi$ Value

When RM Series are in Manual mode, $\text{Cos}\phi$ value and inductive/capacitive state is always displayed. When $\text{Cos}\phi$ value is negative, the system is capacitive and if $\text{Cos}\phi$ value is positive, the system is inductive. In Automatic Operating Mode, system's Present $\text{Cos}\phi$ value and ind./cap. state is displayed by selecting the $\text{Cos}\phi$ LED, by means of UP- DOWN buttons.

5.11 Display of Power Factor (PF) value

When RM Series are in Automatic Operating Mode (AUTO/MAN LED is continuously ON) PF LED is selected by means of DOWN button and system's power factor value is displayed.

This option is disabled in Manual Operating Mode.

Important Definition: $\text{Cos}\phi$ is defined Displacement Power Factor and relative to the fundamental harmonic only. PF is defined Total Power Factor and relative to the all harmonics including fundamental harmonic. In a system without harmonics, PF and $\text{Cos}\phi$ are equal to each other.

Attention: The difference between $\text{Cos}\phi$ and PF values does not mean that voltage harmonics, which results to problems in systems, are high on the network.

5.12 Displaying Voltage and Current RMS Values

When RM Series are in Automatic Mode (AUTO/MAN LED is ON), V LED is selected by means of DOWN button, RMS Voltage (V) value displayed.

If I LED is selected RMS Current (I) value is displayed. Displayed current and voltage values are of the phase where CT is connected. These options are disabled in Manual Operating Mode.

5.13 Display of Active Power (W) Value

When RM Series are in Automatic Operating Mode (AUTO/MAN LED is ON), W LED is selected by means of UP DOWN button and system's Active Power value is displayed. This option is disable in Manual Operating Mode.

5.14 Display of Reactive Power

When RM Series are in Automatic Operating Mode (AUTO/MAN LED is continuously ON), VAR LED is selected by means of UP-DOWN buttons and system's Reactive Power value is displayed. This option is disable in Manual Operating Mode.

5.15 Display of Apparent Power (VA) Value

When RM Series are in Automatic Operating Mode (AUTO/MAN LED is continuously ON), VA LED is selected by means of UP-DOWN buttons and system's Apparent Power value is displayed. This option is disable in Manual Operating Mode.

6. DESCRIPTION

6.1 Errors and Warnings

The Alarm Relay is activated if the following "errors" occur.

6.1.1 Over Voltage

If the phase-neutral voltage of the L1 phase exceeds or equals to preset Over Voltage Value (between 410-480V), the RM Series wait for 3 seconds. At the end of 3 seconds if there is still over voltage the OVER VOLTAGE LED turns on. Depending on selection of Over Voltage Protection function (Pls. refer to 5.9), RM Series switch off the capacitor steps or continues to compensation. Over Voltage error disappears, if set Over Voltage value decreases by 4VAC. In this case OVER VOLTAGE LED turns off and RM Series continue to compensation.

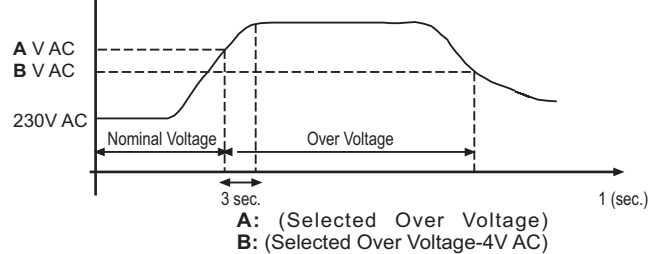

6.1.2 Insufficient Compensation

When target power factor is not reached although all the capacitors steps have been connected, INSUFFICIENT COMPENSATION's LED is ON and the Alarm Relay is activated.

6.1.3 Over Compensation

If the system is still capacitive although all the capacitors steps are disconnected, OVER COMPENSATION LED is ON and Alarm Relay is activated.

6.2 Target $\text{Cos}\phi$

The target $\text{Cos}\phi$ value can be adjusted between 0.85-1.00 inductive. RM Series connects capacitors in order to bring system's power factor to the adjusted value. The adjusted value is defined as $1.25 \times Q_{C1}$ value. Switching operation occurs out of this

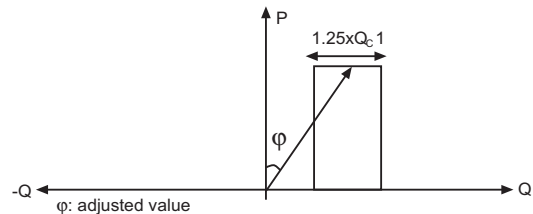

6.3 Adjustable Step Switching Time

Step switching on/off delay time can be adjusted between 2 sec. - 1800 sec.

Warning : Shorter time than above can lead damage in capacitors and conductors.

If capacitor banks have not discharge coils, the delay time must be selected over 14 seconds. The selected delay time must not be shorter than the manufacturer's instruction.

6.4 Switching Program Selection

RM Series has 5 different program modes which determines the power ratio sequence of the capacitor steps.

- PS1 selection ==> 1:1:1:.....:1
- PS2 selection ==> 1:2:2:.....:2
- PS3 selection ==> 1:2:4:.....:4
- PS4 selection ==> 1:2:4:8:....:8
- PS5 selection ==> may be all of the aboves

6.4.1 RM Series Capacitor Sequence Examples

The power ratio selected between capacitor steps is very important. When choosing the ratio between the power of capacitor steps, the rating of each capacitor step value may exceed that of the first by a maximum amount equal to the total of the proceeding capacitor steps value. So the first step value will be the smallest one and the following steps must be the multiples of the first step.

Example: If the first capacitor power is 5 kVar, the capacitor power sequence of the following capacitors are as followed:

- PS1 selection ==> 5.5.5:.....:5
- PS2 selection ==> 5.10.10:.....:10
- PS3 selection ==> 5.10.20:.....:20
- PS4 selection ==> 5.10.20.40:.....:40
- PS5 selection ==> may be all of the aboves

REACTIVE POWER MANAGEMENT

RM Series

Two different switching program is supported by RM Series

a) Rotational Switching : This switching program is rotational between equal steps in the clockwise direction and this switching program is rotational to ensure that the capacitor switching cycles are uniformly distributed over all steps and to provide minimum switching steps for maximum service life time of the system.

There are 4 different rotational switching program options (PS1,PS2,PS3,PS4)

b) Linear Operation : The switching program begins always from the first step to the last one in both switching on and off mode. The advantage of this switching program is the possibility of a large selection of capacitor steps conform to the step function ratio rule as explained above. The maximum possible ratio is "x:2x:4x:8x:16x.....".

The switching program is selected by PS5 option.

6.5 Step Number Selection

by selecting the step number the extra time is spent connecting on/off the unused capacitor steps, is eliminated. As a result, compensation system is used more effective and efficient. If step number is not selected, RM Series makes the compensation according to the factory set step number which is max. Available output as defined on the front panel.

6.6 C/k Setting

The C/k value is a threshold value of switching on/off the capacitor steps, C/k is the value obtained by dividing first step capacitor power "C" to the Current Transformer Ratio "k". This value is measured and calculated by RM Series automatically, or this value can be entered manually. After pressing the UP and DOWN buttons together, the C/k value is calculated and stored in one step switching on/off time interval. The further compensation controls are made with this stored value. In case of instantaneous change of the system's load, measuring process will be renewed. RM Series will stop the measuring after 10 attempt. It means that the C/k value couldn't be measured due to the instability of the system's load. In this case compensation control will continue with the pre-stored value in the memory.

The formula to calculate the C/k value is :

$$C/k = \frac{C}{k}$$

Q: Power of the first step capacitor (kVar)
k: Current Transformer Ratio (CTR)

Example:

Let the power (C) of the first step capacitor is 5 kVar and the Current Transformer Ratio (k) is 100/5. Then the C/k value is:

$$C/k = 5/(100/5) = 0.25$$

C/k value for the different C and k values are as followed:

CTR (k)	Power of Capacitor Step (kVar) (C)											
	2.5	5	10	12.5	15	20	25	30	40	50	60	100
30/5	0.42	0.83										
50/5	0.25	0.50	1.00									
75/5	0.17	0.33	0.67	0.83	1.00							
100/5	0.13	0.25	0.50	0.63	0.75	1.00						
150/5	0.08	0.17	0.33	0.42	0.50	0.67	-0.83	1.00				
200/5	0.06	0.13	0.25	0.31	0.38	0.50	0.63	0.75	1.00			
300/5	0.04	0.08	0.17	0.21	0.25	0.33	0.42	0.50	0.67	0.83	1.00	
400/5	0.03	0.06	0.13	0.16	0.19	0.25	0.31	0.38	0.50	0.63	0.75	
500/5		0.05	0.10	0.13	0.15	0.20	0.25	0.30	0.40	0.50	0.60	1.00
600/5			0.08	0.10	0.13	0.17	0.21	0.25	0.33	0.42	0.50	0.83
800/5			0.06	0.08	0.09	0.13	0.16	0.19	0.25	0.31	0.38	0.63
1000/5			0.05	0.06	0.08	0.10	0.13	0.15	0.20	0.25	0.30	0.50
1250/5				0.05	0.06	0.08	0.10	0.12	0.16	0.20	0.24	0.40
1500/5					0.05	0.07	0.08	0.10	0.13	0.17	0.20	0.33
2000/5						0.05	0.06	0.08	0.10	0.13	0.15	0.25
2500/5							0.05	0.06	0.08	0.10	0.12	0.20
3000/5								0.05	0.07	0.08	0.10	0.17
4000/5									0.05	0.06	0.08	0.13

6.7 Current Transformer (CT) Selection

RM Series have four quadrant measuring and operation feature. So: it is able to sense the energy flow direction and correcting itself for right compensation.

6.8 Current Transformer (CT) Selection

Always a separate CT must be used for the power Factor Controller. The wires connecting CT to Power Controller must be as short as possible and the diameter of wire not less than 1.5 mm. Since the current information is supplied by CT, the right selection of CT is very important. The secondary current of the selected CT must comply with the following current limits for correct measuring.

Minimum=0.05 mA ,Maximum=5.5 A (Minimum C/k Ratio must be 0.02)

7. ERROR DESCRIPTIONS

7.1 Wrong Cosφ

Current and Voltage phase connections are not correct.

7.2 Insufficient Compensation

The Power value of the capacitor steps may decreased by time. The fuses which are drawn by devices like ballasts constant steps etc. The power of the capacitor steps may have been insufficient to compensate the system. (In this case user must increase the capacitor power.

7.3 Over Compensation

This occurs (especially at weekends, nights etc.) due to capacitive load current drawn by devices like ballasts constant steps etc. The contactor's contacts switching the capacitor steps may have stuck to each other due to the instantaneous over current. Unnecessary capacitor steps may have switched on manually.

7.4 Over Voltage

The phase-neutral voltage of L1 has exceeded the preset Over Voltage Value.

8. EASY INSTALLATION RECOMMENDATION (IMPORTANT NOTICE)

When the load is unstable and varies very quickly, the C/k calculation process may take long time or in some cases it can not be calculated properly or miscalculated which may cause improper compensation. A practical way to prevent this situation is as followed.

1- Turn on the compensation board without connecting the load current. Only the capacitors will be in operation in this situation. (You can do this by switching off the load current temporarily)

2- Start the C/k calculation process by pressing the UP and DOWN buttons at the same time. Now, depending on the power of the first step, C/k value is calculated very accurately by RM Series. The calculated C/k value will automatically be stored in the memory. You can switch the load on. This C/k value will be kept in the memory until it is recalculated or changed manually.

9. TECHNICAL SPECIFICATIONS

Rated Voltage (Un)	: 380,400,415 VAC(Phase-Phase Connection) (Phase-Neutral Connection)
Operating Voltage Range (ΔU)	: (0.9-1.1)xUn
Operating Current Range (ΔI)	: 50mA-5.5A
Rated Frequency (f)	: 50 Hz / 60 Hz
Measuring Class	: 1% ± 1 digit (V, I, Cosφ), 2% ± 1 digit (W, VAr, VA)
Power Consumption	: Current: <2 VA Voltage: 3 VA-10 VA
Output Contact	: 3A, 750VA (NO Contact)
No-Volt Feature	: In case of power failure longer than 200 msec. all capacitor steps are disconnected automatically.
Setting Range	: Manual C/k Setting: 0.02-1.00 Cosφ Setting: 0.85 (ind.)-1.00 CT Ratio: 5-10000
Time Delay	: Between 2 sec.-1800 sec.
Over Voltage Values (Selectable)	: 410-480 V(Programmable)Un=380,400,415V AC
Factory Set Values	: Cosφ= 1.00 (ind.), Step Time= 7 sec. Program= PS5, C/k= 0.05 CT Ratio= 5-10000
Number of Steps	: RM-12 (Max 12a); RM-8 M(Max 8)
Ambient Temperature	: -5°C - 55°C
Display	: 4 Digit, Red Display
Equipment Protection Class	: Double Insulation-Class II (□)
Wire Section (for Terminal Block)	: 2.5mm ²
Terminal Block Protection Class	: IP 00
Protection Class	: IP 40
Connections	: Socket terminals with screw
Dimensions	: Type PR 16
Switchboard cut-out	: 139x139 mm
Weight	: 0.8 kg.

